

Tolleranze secondo ISO 2548 classe C	Autoinnescante/Selfpriming		Tolerances according ISO 2548 C class
Velocità di rotazione [giri/min]	1000-1500-2000		Rotating speed [rpm]
Densità dell'acqua alla prova	1000	kg/m ³	Water density at test
Passaggio corpi solidi (max diametro sfera)	N.S.	mm	Solid handling (max.diameter sphere)
Diametro girante	139	mm	Impeller diameter
Inerzia delle masse rotanti (innesto inserito)	-	Kgm ²	Inerthia of rotating parts (engaged clutch)
Forza richiesta per l'azionamento dell'innesto	250	N	Clutch engaging effort
Altezza di innesco massima a 2000 giri/min	6.5	m	Maximum priming lift at 2000 rpm
Massa della pompa	18	kg	Pump mass

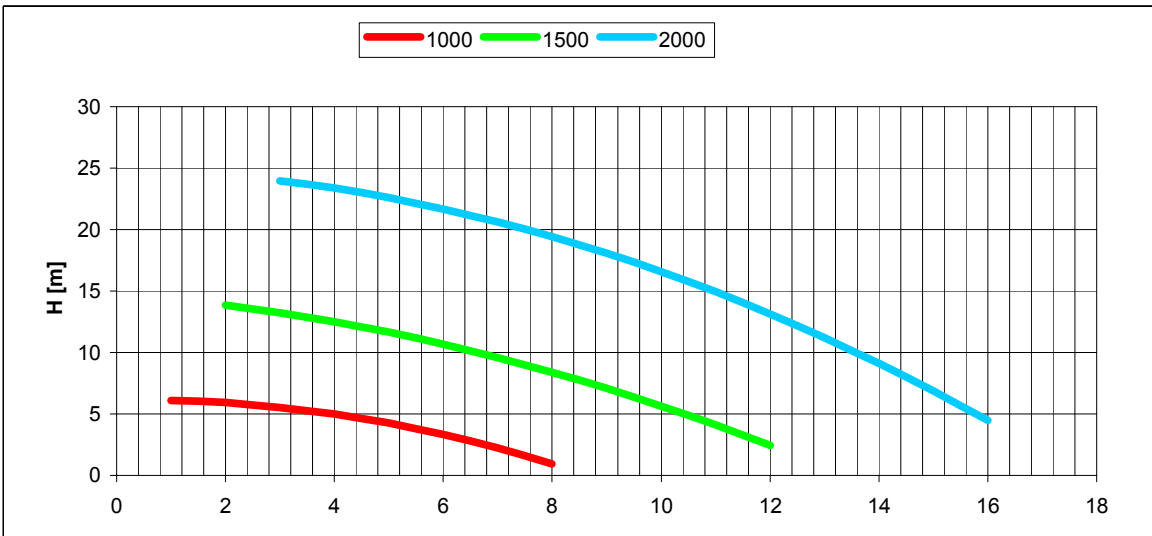

H(Q)
Prevalenza totale
Total head

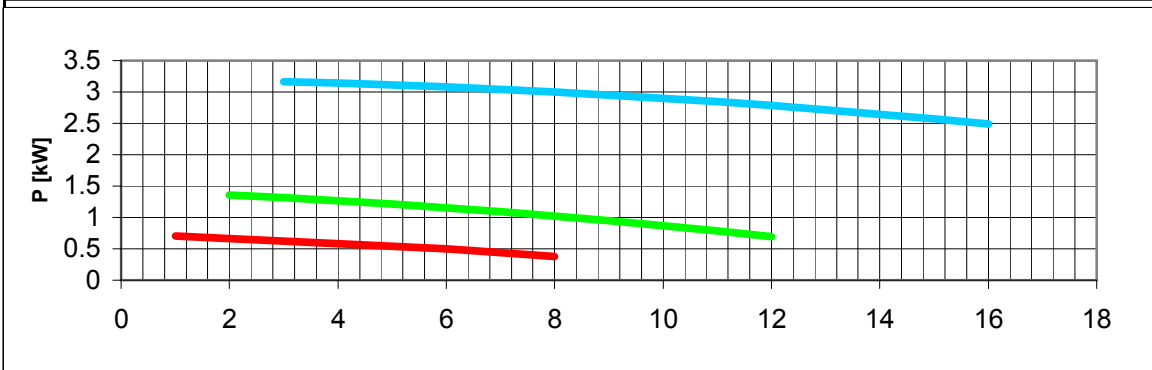

P(Q)
Potenza richiesta
Required power

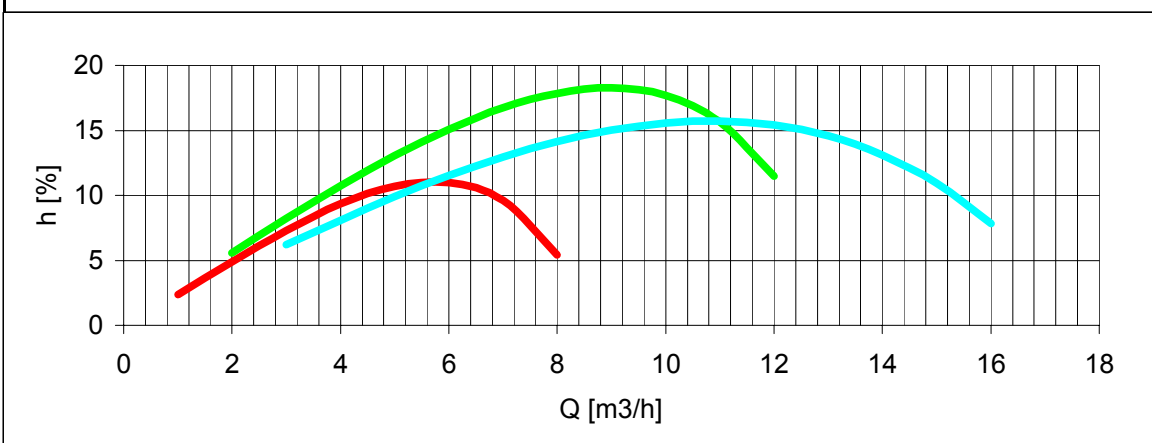

η
Rendimento pompa
Pump efficiency

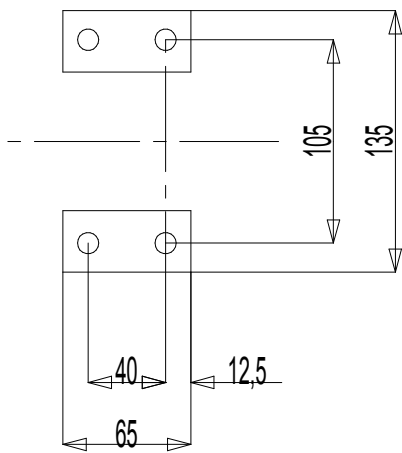
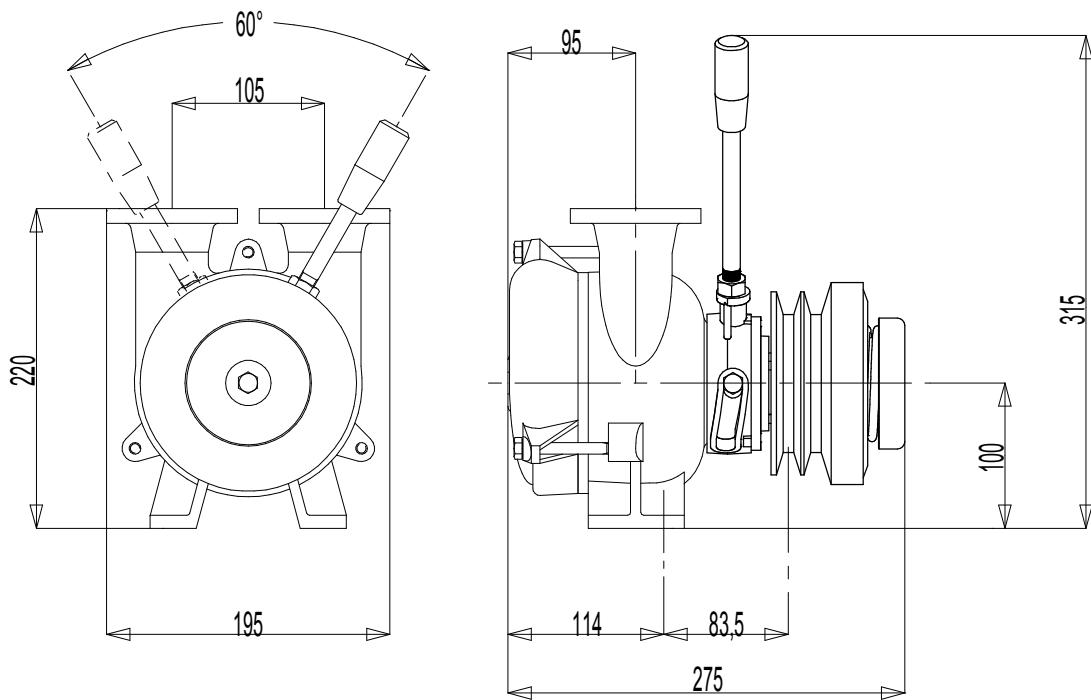

Dimensioni piedi

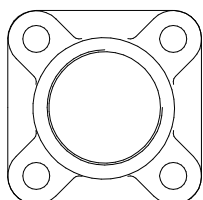
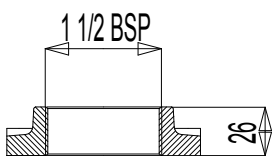

Controflangia aspirazione
Controflangia mandata

Flangia aspirazione
Flangia mandata

